



Duurzaam
Riel Goirle

Warmtepompen



Principe

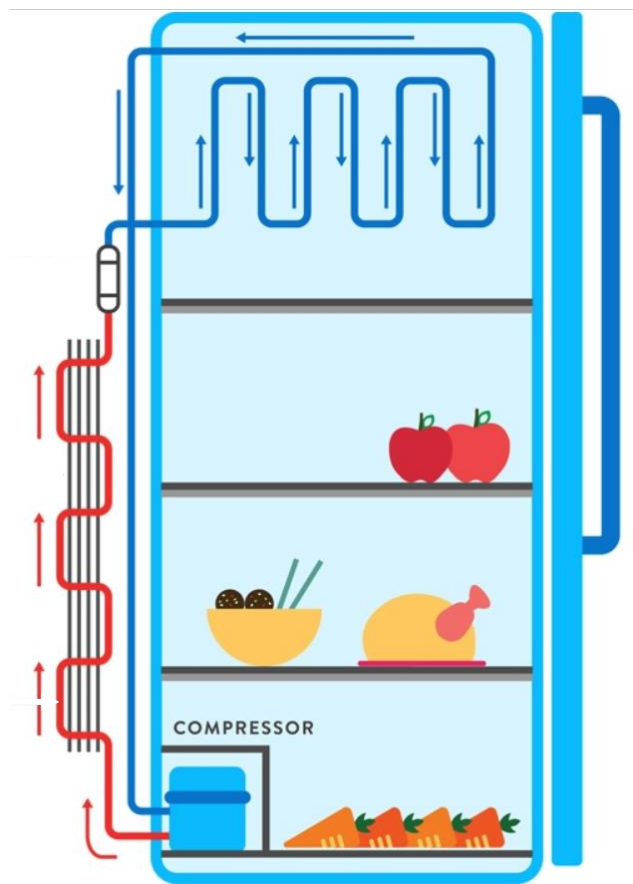

Koelkast

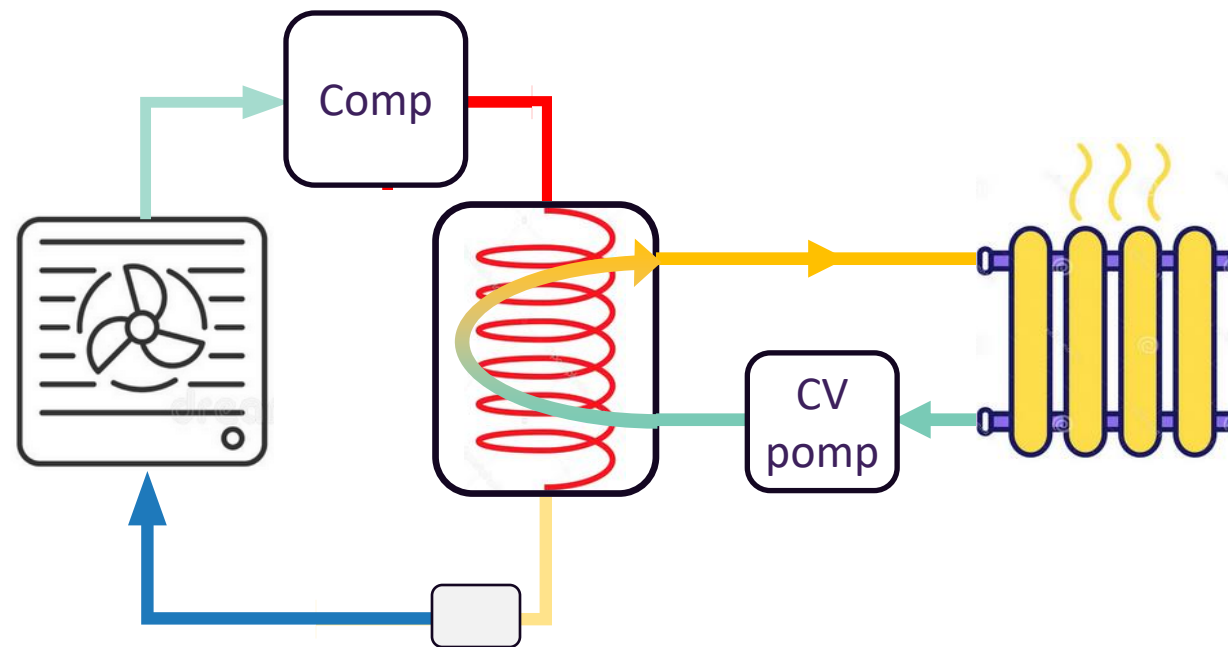

Warmtepomp



Waarom een warmtepomp?

Milieu + Kosten

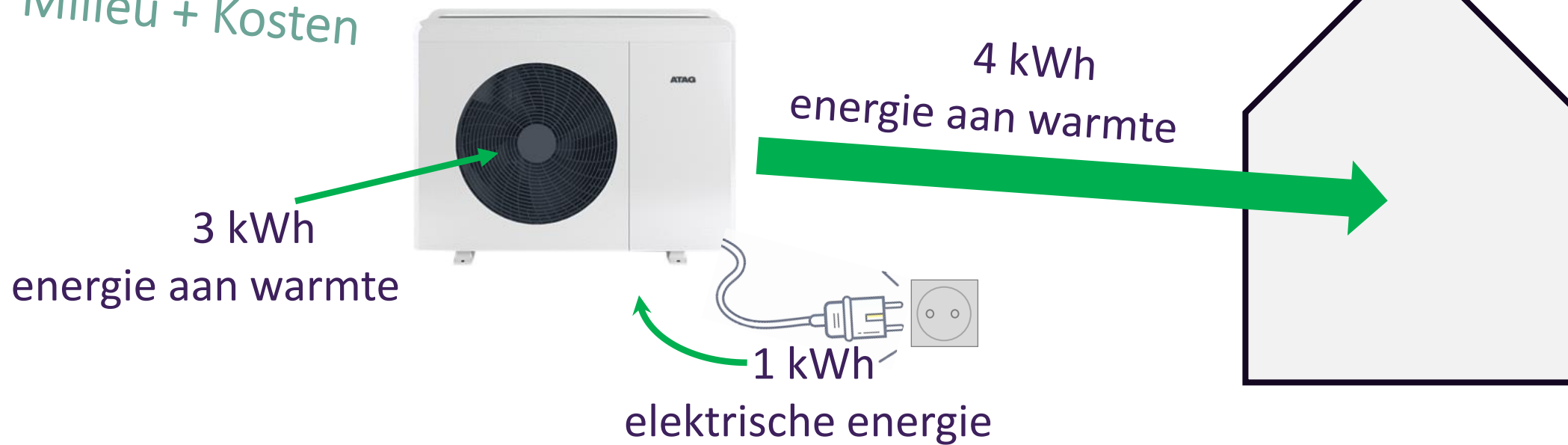

Wat kost deze hoeveelheid energie ?



Waarom een warmtepomp?

Milieu + Kosten

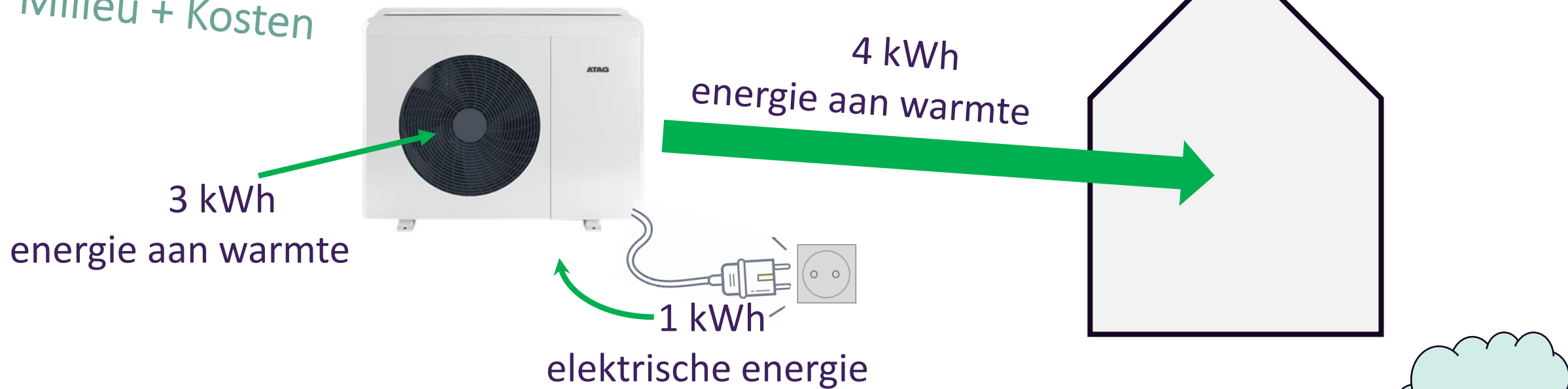

Wat kost deze 4 kWh energie uit:

CV-ketel : ongeveer € 0,70

Warmtepomp: ongeveer € 0.35



Soorten warmtepompen: de Bron

Warmte uit de lucht

Lucht-water-



Lucht-lucht-



Warmte uit water

Water-water-

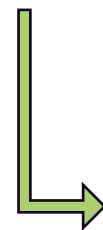

Bodemwarmte
of
dakpanelen (PVT)



Lucht-water warmtepompen



Duurzaam
Riel Goirle

Hybride ← ??? → All-electric

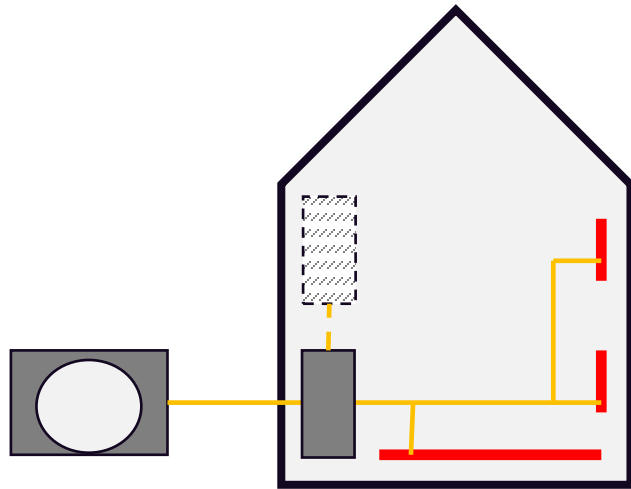

Split unit
(hybride)

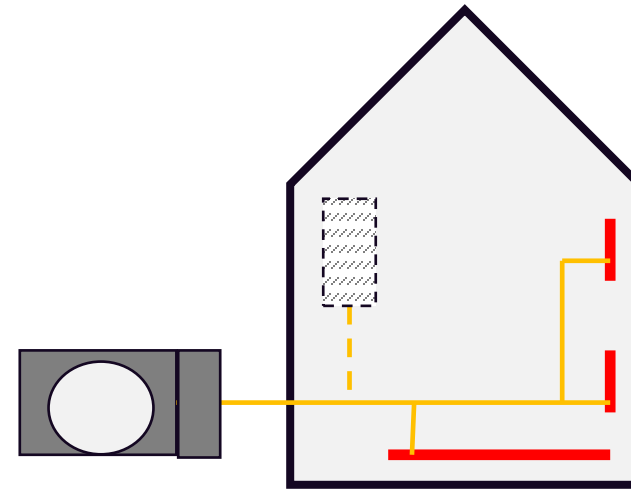

Monoblock
(hybride)



Verschillen hybride – All electric

	Hybride	All electric
Gasloos	--	✓
Kan zonder boiler	✓	--
Energiebesparend	✓	✓
Ruimte besparend	✓	--
Kan bij matig geïsoleerde woning	✓	--
Energiebesparing warm water	--	✓
Kan zonder vloerverwarming	✓	~
Overheidssubsidie	✓	✓



Wanneer een warmtepomp

1. isoleren, dak, vloer, muren, ramen.
2. 50°-test

Streefwaarde: verbruik onder
1000 m³/jaar

Eerst doen anders is
de warmtepomp
later te zwaar

Voor 2-onder een
kap



Duurzaam
Riel Goirle

Waar vind ik informatie

Onafhankelijke, deugdelijke en niet commerciële informatie:

Energiecoach van Duurzaam Riel Goirle

Milieucentraal.nl

Verbeterjehuis.nl



Duurzaam
Riel Goirle

Vragen en discussie

